

Mucin type O-glycan biosynthesis

all genes

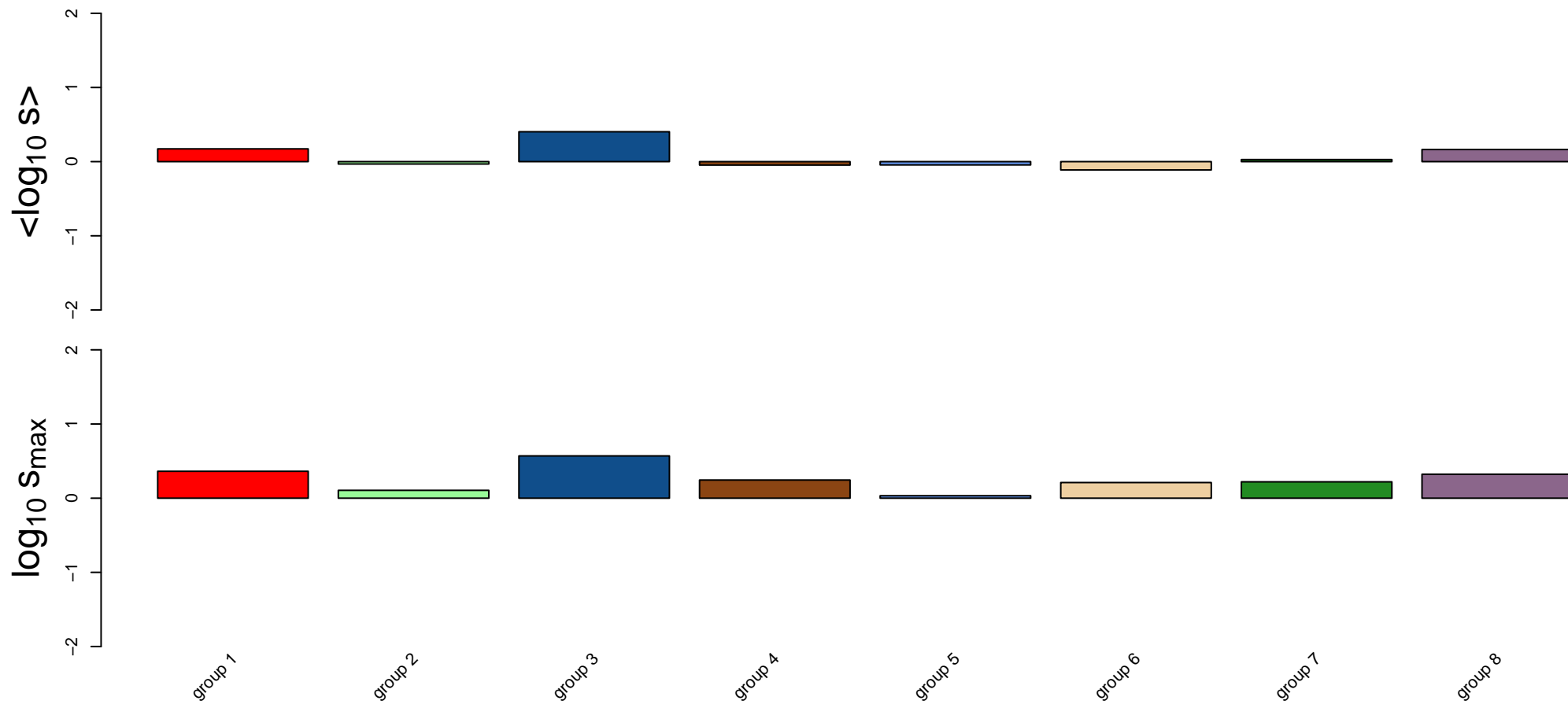

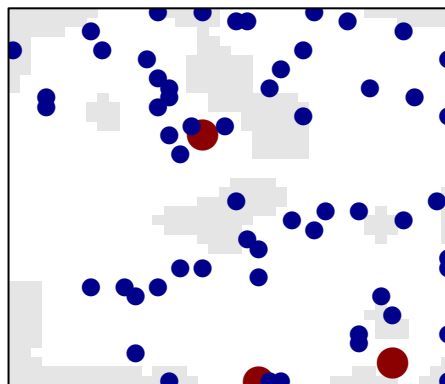
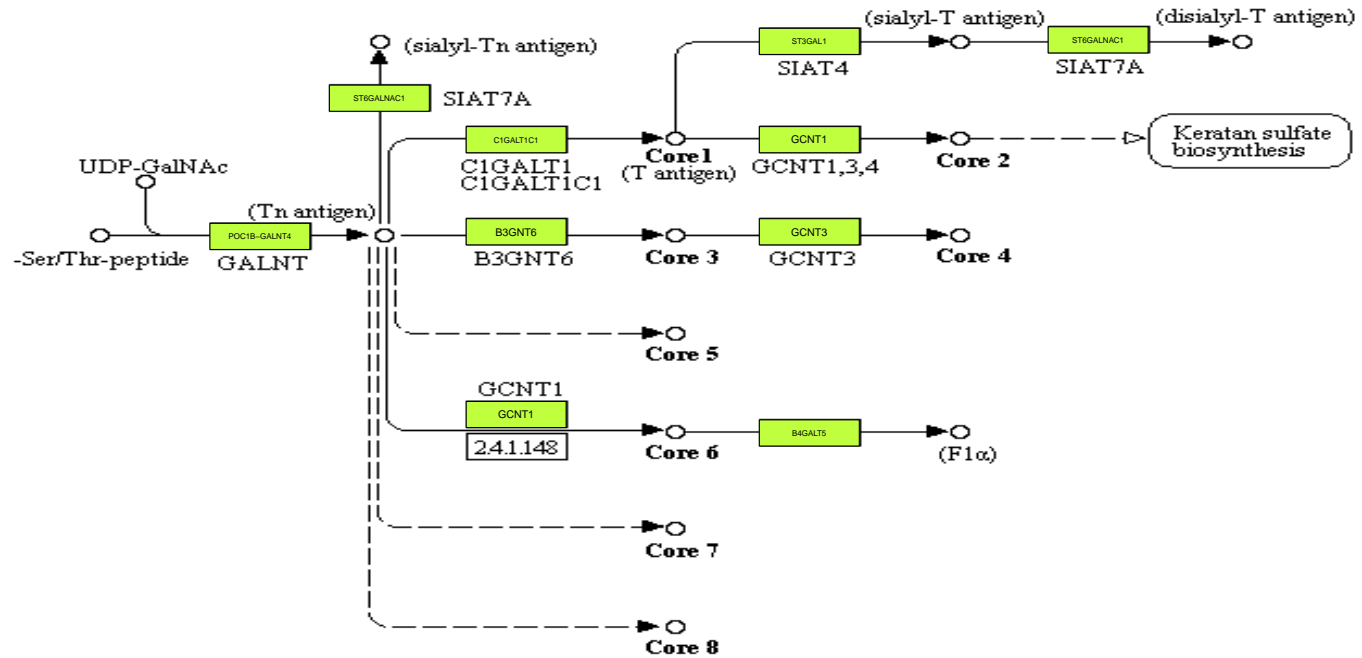

Tn antigen

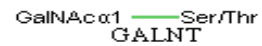

Sialyl-Tn antigen

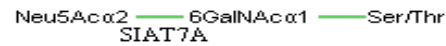

Disialyl-T antigen

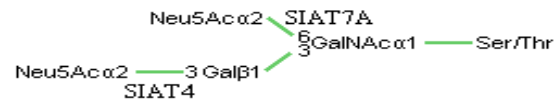

Core 1, 2

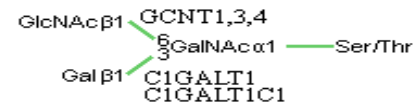

Core 3, 4

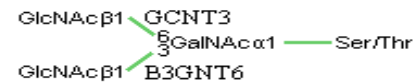

Core 5



Core 6 & F1 α



Core 7



Core 8



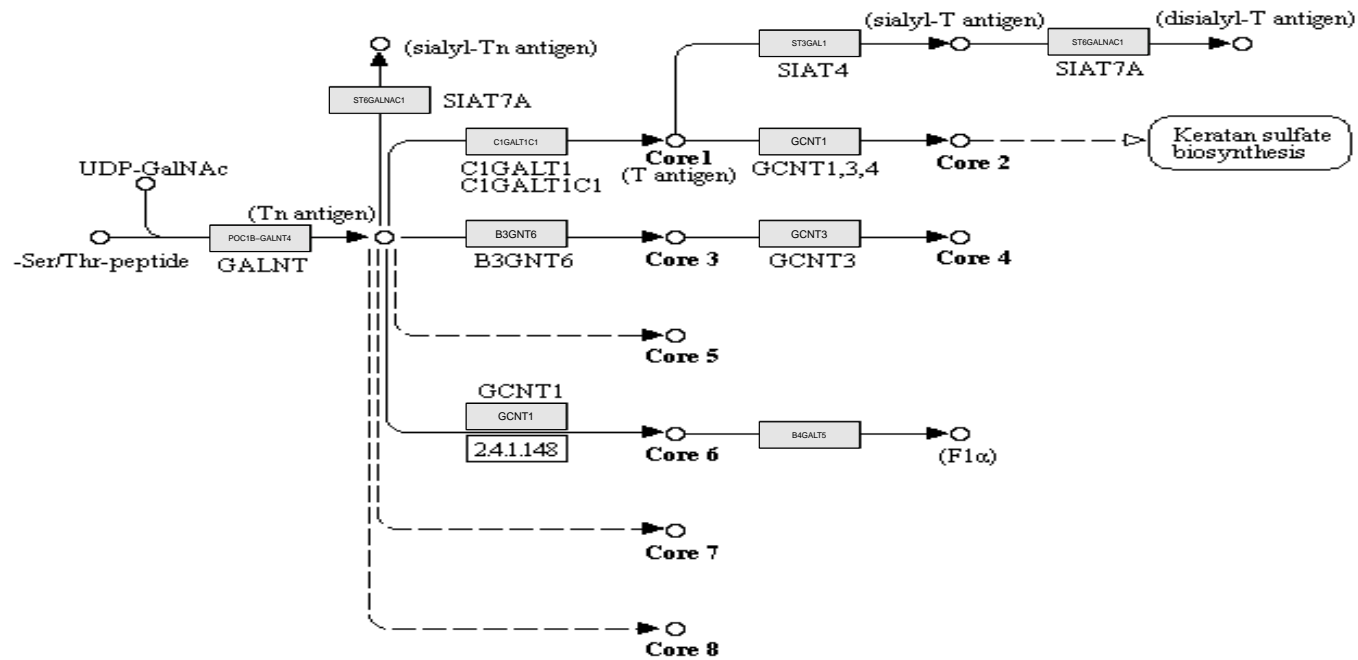

Tn antigen

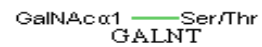

Sialyl-Tn antigen

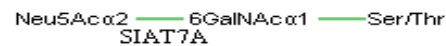

Disialyl-T antigen

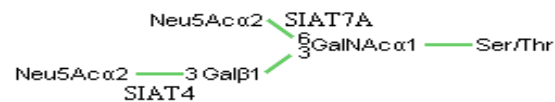

Core 1, 2

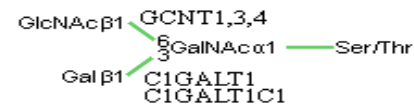

Core 3, 4

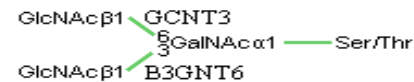

Core 5



Core 6 & F1 α



Core 7



Core 8



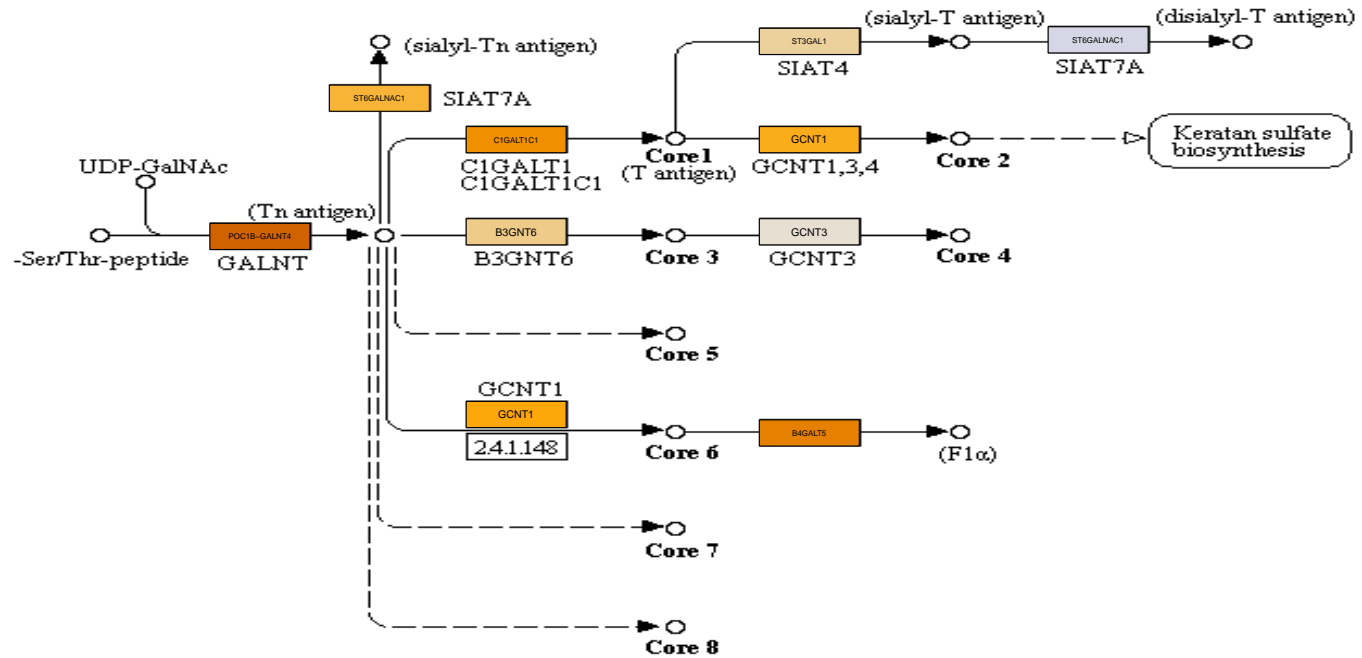

Tn antigen

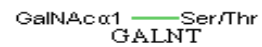

Sialyl-Tn antigen

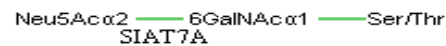

Disialyl-T antigen

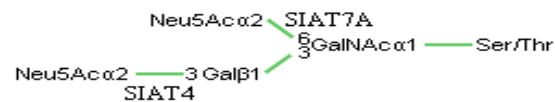

Core 1, 2

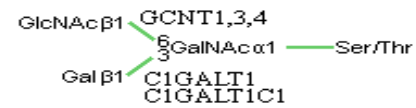

Core 3, 4

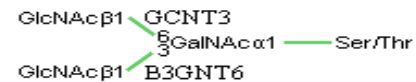

Core 5



Core 6 & F1 α



Core 7



Core 8



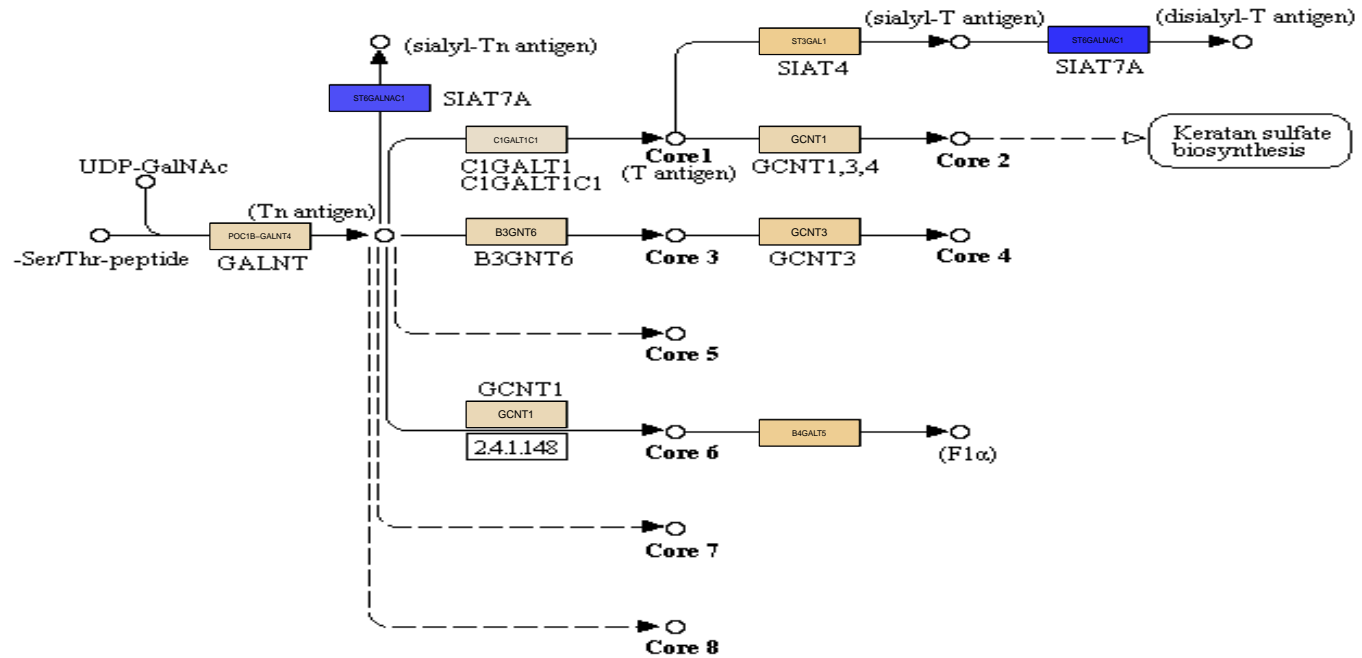

Tn antigen

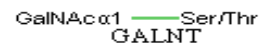

Sialyl-Tn antigen

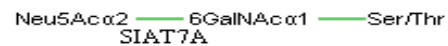

Disialyl-T antigen

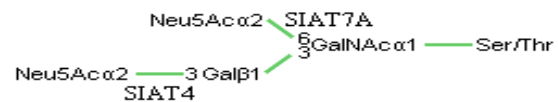

Core 1, 2

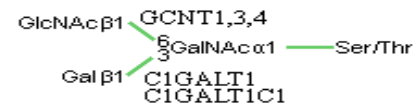

Core 3, 4

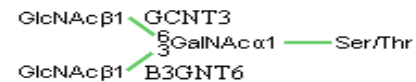

Core 5



Core 6 & F1 α

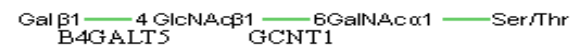

Core 7



Core 8



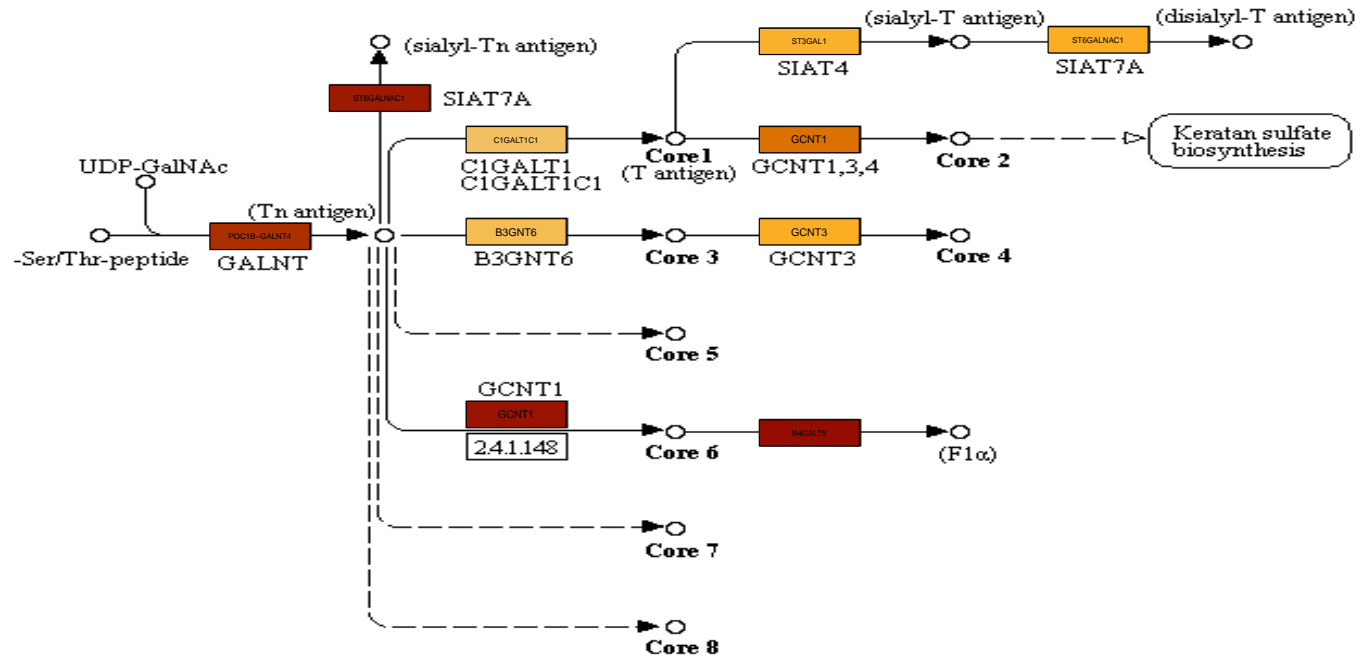

Tn antigen

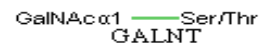

Sialyl-Tn antigen

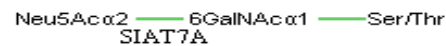

Disialyl-T antigen

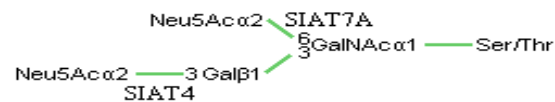

Core 1, 2

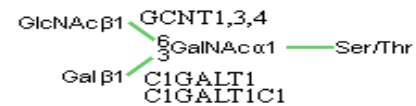

Core 3, 4

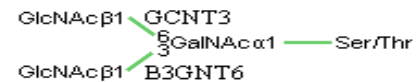

Core 5



Core 6 & F1 α

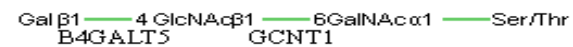

Core 7



Core 8



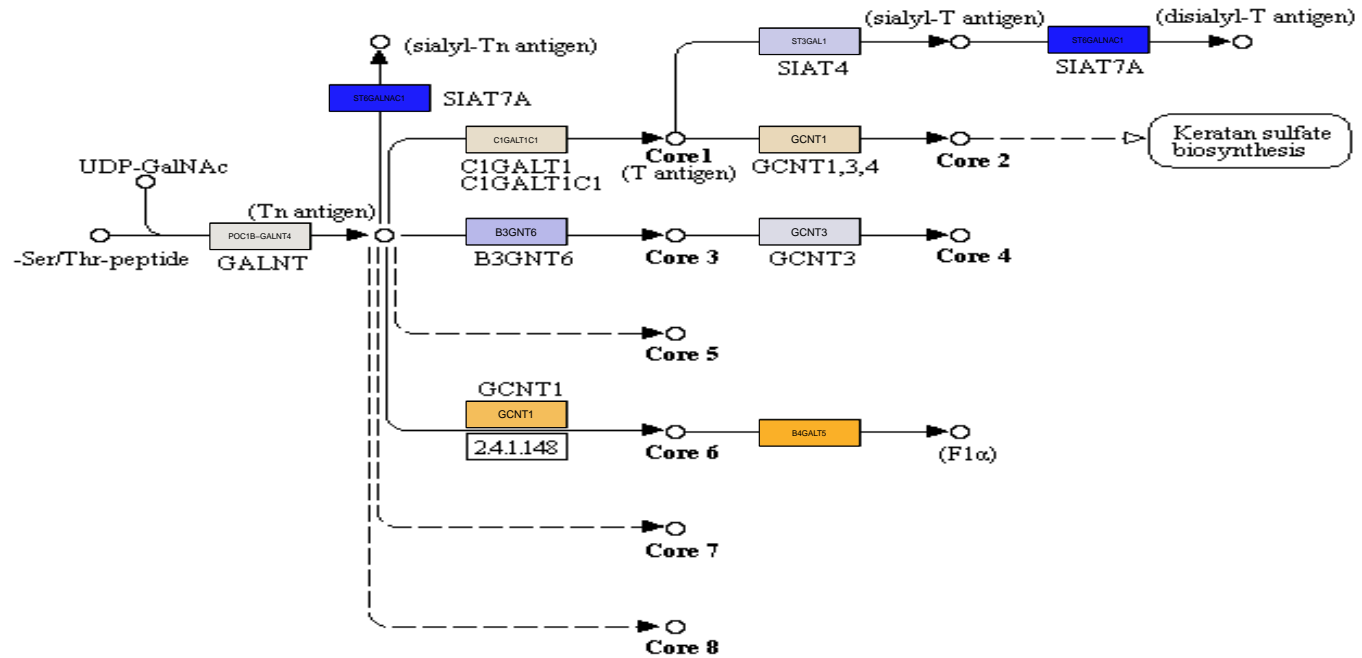

Tn antigen

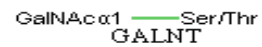

Sialyl-Tn antigen

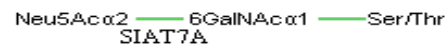

Disialyl-T antigen

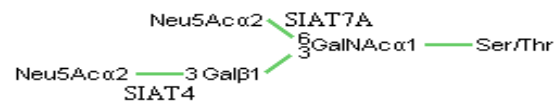

Core 1, 2

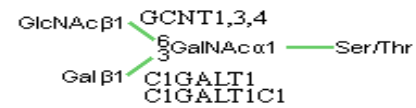

Core 3, 4

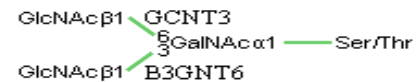

Core 5



Core 6 & F1 α

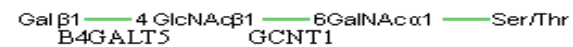

Core 7



Core 8



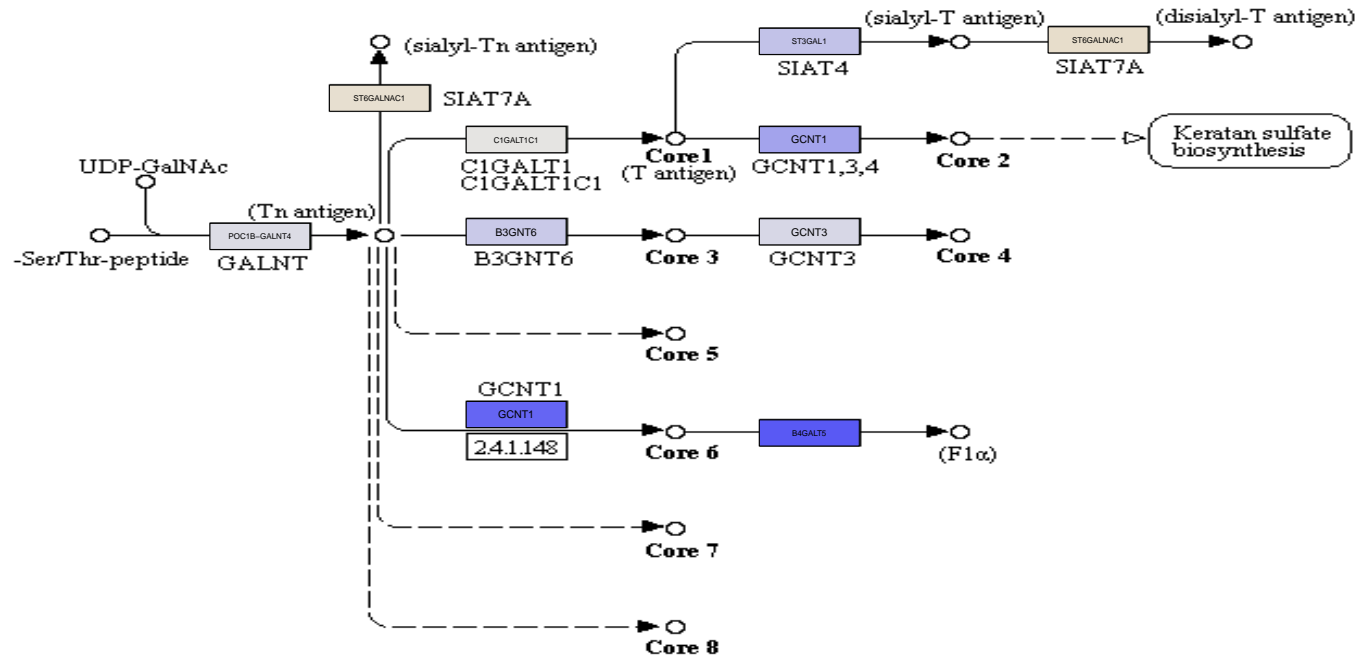

Tn antigen

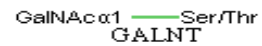

Sialyl-Tn antigen

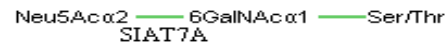

Disialyl-T antigen

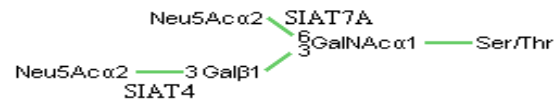

Core 1, 2

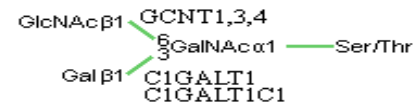

Core 3, 4

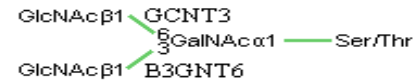

Core 5



Core 6 & F1 α

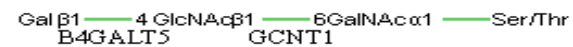

Core 7



Core 8



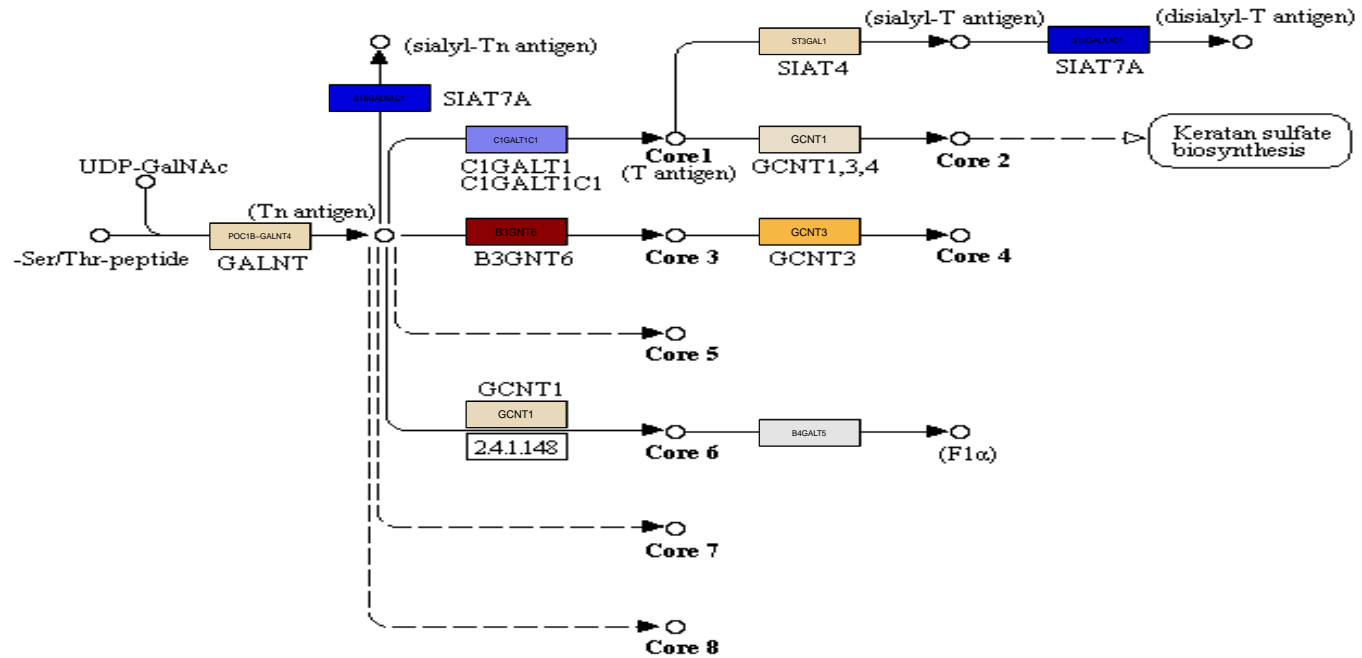

Tn antigen

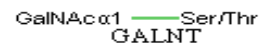

Sialyl-Tn antigen

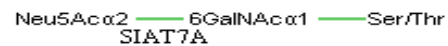

Disialyl-T antigen

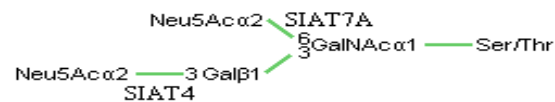

Core 1, 2

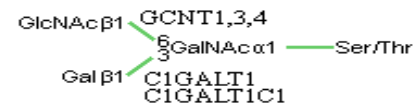

Core 3, 4

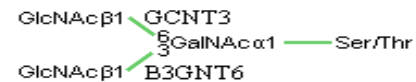

Core 5



Core 6 & F1 α



Core 7



Core 8



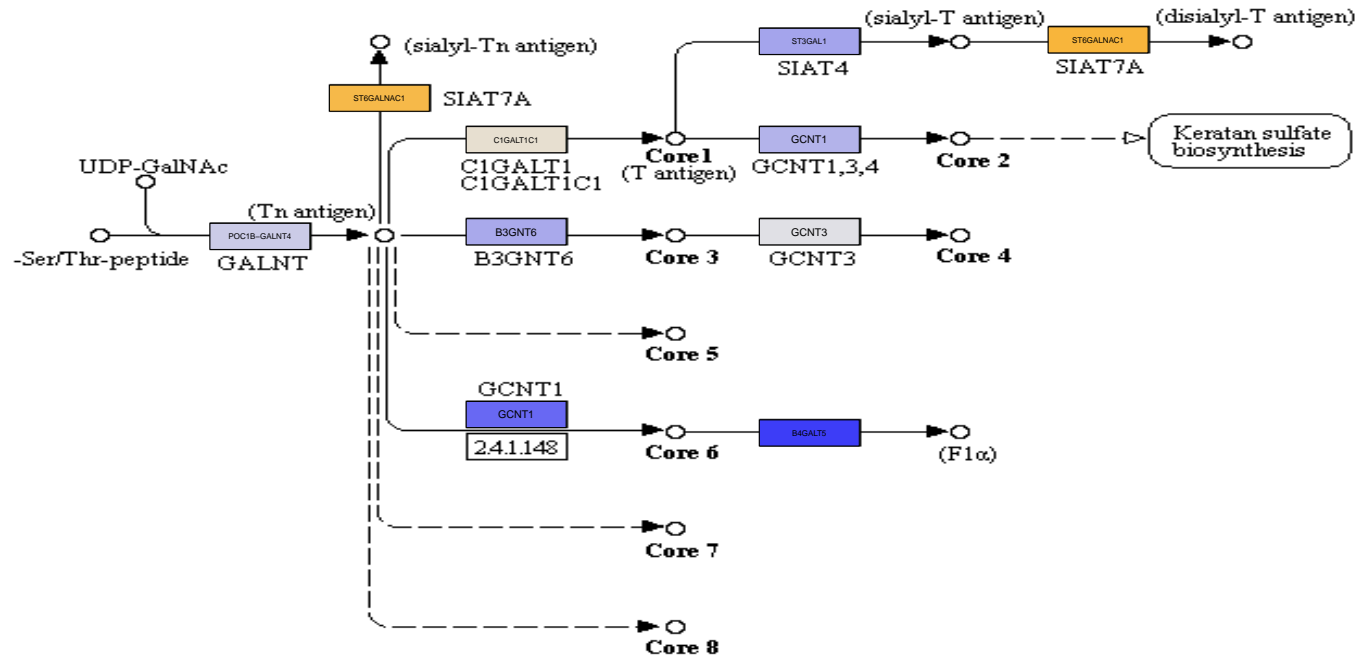

Tn antigen

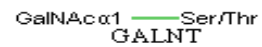

Sialyl-Tn antigen

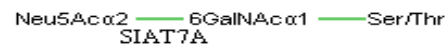

Disialyl-T antigen

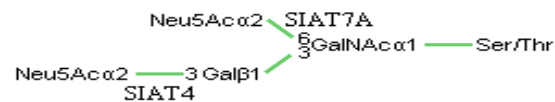

Core 1, 2

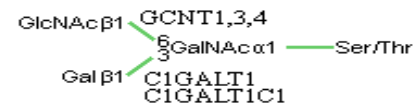

Core 3, 4

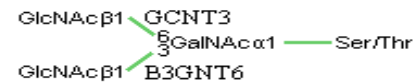

Core 5



Core 6 & F1 α

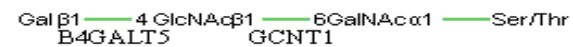

Core 7



Core 8



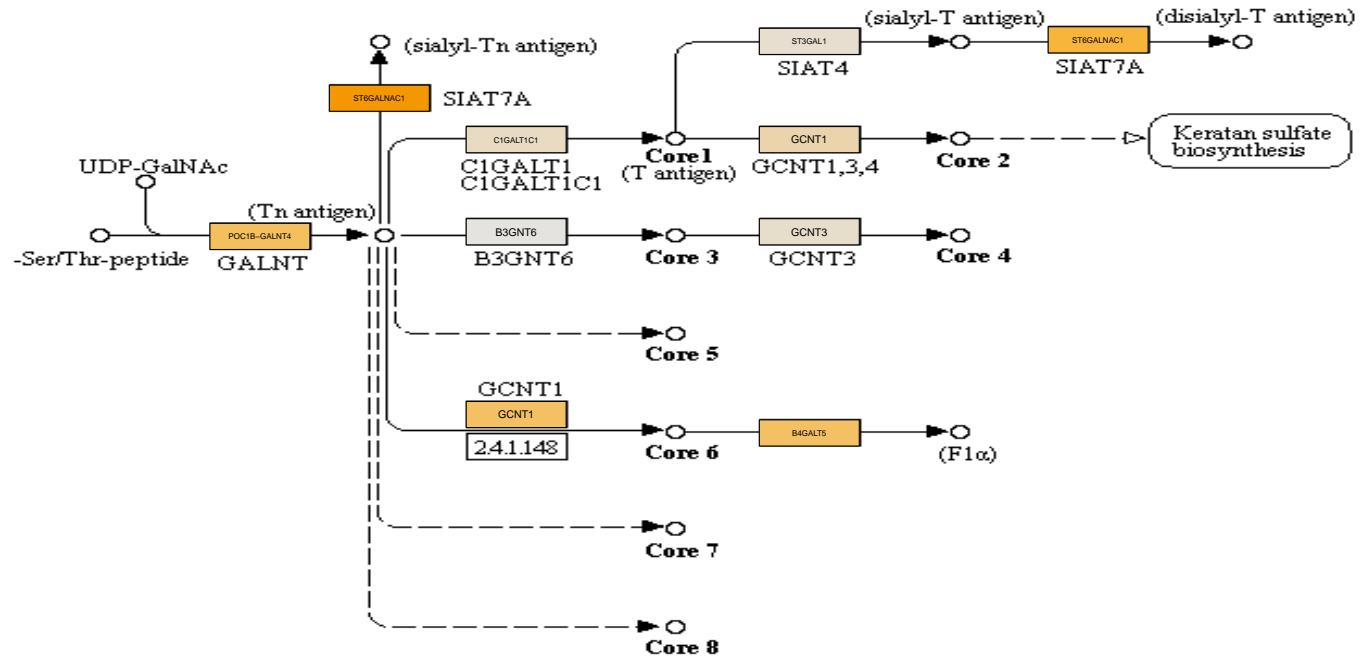

Tn antigen

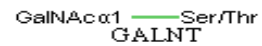

Sialyl-Tn antigen

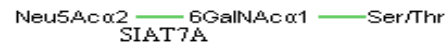

Disialyl-T antigen

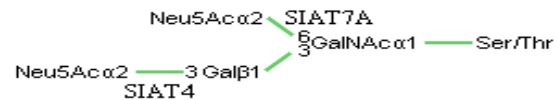

Core 1, 2

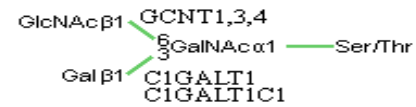

Core 3, 4

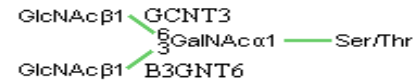

Core 5



Core 6 & F1 α

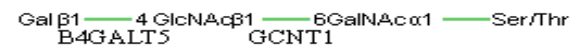

Core 7



Core 8

